

REVIEW ARTICLE

Exploration of the primary visual cortex, 1955–78

David H. Hubel*

The following article is the lecture delivered by the author in Stockholm on 8 December 1981 when he received the Nobel Prize in Medicine or Physiology which he shared with Roger Sperry and Torsten Wiesel. The article is published here with permission from the Nobel Foundation and will also be included in the complete volume of Les Prix Nobel en 1981 as well as in the series Nobel Lectures (in English) published by Elsevier. The lecture of Dr Wiesel will appear in next week's issue.

IN the early spring of 1958 I drove over to Baltimore from Washington DC, and in a cafeteria at Johns Hopkins Hospital met Stephen Kuffler and Torsten Wiesel for a discussion that was more momentous for Torsten's and my future than either of us could have possibly imagined.

I had been at Walter Reed Army Institute of Research for 3 years, in the Neuropsychiatry Section headed by David Rioch, working under the supervision of M. G. F. Fuortes. I began at Walter Reed by developing a tungsten microelectrode and a technique for using it to record from cats with permanently implanted electrodes, and I had been comparing the firing of cells in the visual pathways of sleeping and waking animals.

It was time for a change in my research tactics. In sleeping cats, only diffuse light could reach the retina through the closed eyelids. Whether the cat was asleep or awake, diffuse light failed to stimulate the cells in the striate cortex. In waking animals I had succeeded in activating many cells with moving spots on a screen, and had found that some cells were very selective in that they responded to movement when a spot moved in one direction across the screen (for example, from left to right) but not when it moved in the opposite direction¹ (Fig. 1). There were many cells that I could not influence at all. Obviously there was a gold mine in the visual cortex, but methods were needed that would permit recording of single cells for many hours, and with the eyes immobilized, if the mine were ever to begin producing.

I had planned to do a postdoctoral fellowship at Johns Hopkins Medical School with Vernon Mountcastle, but the timing was awkward for him because he was remodelling his laboratories. One day Kuffler called and asked if I would like to work in his laboratory at the Wilmer Institute of Ophthalmology at the Johns Hopkins Hospital with Torsten Wiesel, until the remodelling was completed. That was expected to take about a year. I did not have to be persuaded; some rigorous training in vision was just what I needed, and though Kuffler himself was no longer working in vision the tradition had been maintained in his laboratory. Torsten and I had visited each other's laboratories and it was clear that we had common interests and similar outlooks. Kuffler suggested that I come over to discuss plans, and that was what led to the meeting in the cafeteria.

It was not hard to decide what to do. Kuffler had described two types of retinal ganglion cells which he called 'ON-centre' and 'OFF-centre'. The receptive field of each type was made up of two mutually antagonistic regions, a centre and a surround, one excitatory and the other inhibitory. In 1957, Barlow, FitzHugh and Kuffler had gone on to show that, as a consequence, retinal ganglion cells are less sensitive to diffuse light than to a spot just filling the receptive-field centre². It took me some time to realize what this meant: that the way a cell responds to any visual scene will change very little when, for example, the sun goes behind a cloud and the light reflected

from black and white objects decreases by a large factor. The cell virtually ignores this change, and our subjective assessment of the objects as black or white is likewise practically unaffected. Kuffler's centre-surround receptive fields thus began to explain why the appearance of objects depends so little on the intensity of the light source. Some years later Edwin Land showed that the appearance of a scene is similarly relatively independent of the exact wavelength composition of the light source. The physiological basis of this colour independence has yet to be worked out.

The strategy (to return to our cafeteria) seemed obvious. Torsten and I would simply extend Stephen Kuffler's work to the brain; we would record from geniculate cells and cortical cells, map receptive fields with small spots, and look for any further processing of the visual information.

My reception in Kuffler's office the first day was memorable. I was nervous and out of breath. Steve, at his desk, rotated around in his chair and said "Hi David! Take off your coat, hang up your hat, do up your fly". His manner was informal! But it took me a month, given my Canadian upbringing, to force myself to call him Steve. For the first three months no paycheck arrived, and finally I screwed up the courage to go in and tell him. He laughed and laughed, and then said, "I forgot!"

Torsten and I did not waste much time. Within a week of my coming to Hopkins (to a dark and dingy inner windowless room at the Wilmer Institute basement, deemed ideal for visual studies) we did our first experiment. For the time being we finessed the geniculate (at Walter Reed I had convinced myself that the cells were centre-surround) and began right away with cortex. The going was rough. We had only the equipment for retinal stimulation and recording that had been designed a few years before by Talbot and Kuffler³. A piece of apparatus resembling a small cyclotron held the anaesthetized and paralysed cat with its head facing almost directly upward. A modified ophthalmoscope projected a background light and a spot stimulus onto the retina. The experimenter could look in, see

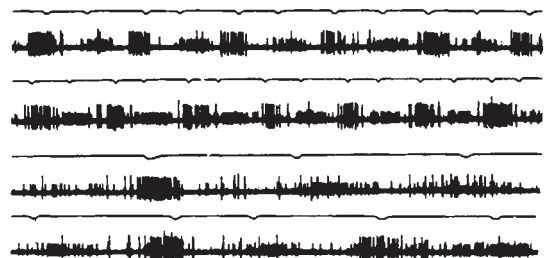

Fig. 1 Continuous recording from the striate cortex of an unrestrained cat. In each dual trace, the lower member shows the microelectrode oscilloscope recording from two cells, one with large impulses, the other with smaller ones. The stimulus was small to-and-fro hand movements in front of the cat. Each movement interrupted a light beam falling on a photoelectric cell, producing the notches in the upper beam. The upper two pairs of records represent fast movements, the lower ones slower movements. Each line represents 4 s¹.

* The author is John Franklin Enders University Professor at Harvard University, and is affiliated with the Department of Neurobiology, Harvard Medical School, Boston, Massachusetts 02115, USA.

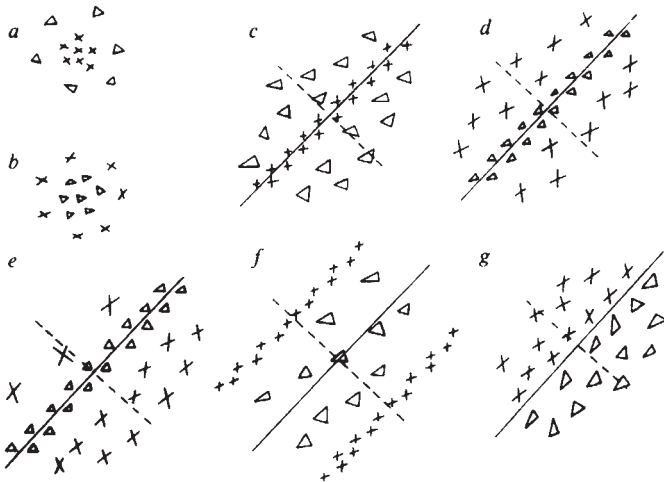

Fig. 2 Common arrangements of lateral geniculate (a, b) and simple cortical (c-g) receptive fields. Symbols: X, areas giving excitatory (ON) responses; Δ , areas giving inhibitory (OFF) responses. Receptive-field orientations are shown by continuous lines through field centres; in this figure these are all oblique, but each arrangement occurs in all orientations (Fig. 2 in ref. 10).

the retina with its optic disk, area centralis, and blood vessels, and observe the background light and the stimulus spots. Small spots of light were produced by sliding 2×5 cm metal rectangles containing various sizes of holes into a slot in the apparatus, just as one puts a slide into a slide projector. To obtain a black spot on a light background one used a piece of glass like a microscope slide, onto which a black dot had been glued. All this was ideal for stimulating the retina and recording directly from retinal ganglion cells, since one could see the electrode tip and know where to stimulate, but for cortical recording it was horrible. Finding a receptive field on the retina was difficult, and we could never remember what part of the retina we had stimulated. After a month or so we decided to have the cat

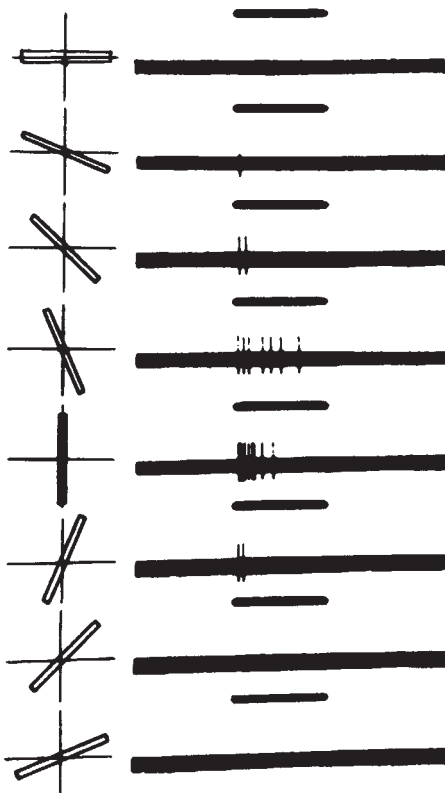

Fig. 3 Responses to shining a rectangular slit of light $1^\circ \times 8^\circ$, so that centre of slit is superimposed on centre of receptive field in various orientations. Receptive field is of type C (see Fig. 2), with the axis vertically oriented (Fig 3 in ref. 12).

face a projection screen, as I had at Walter Reed and as Talbot and Marshall had in 1941⁴. Having no other head holder, we continued for a while to use the ophthalmoscope's head holder, which posed a problem since the cat was facing directly up. To solve this we brought in some bed sheets which we slung between the pipes and cobwebs that graced the ceiling of the Wilmer basement, giving the setup the aura of a circus tent. On the sheets we projected our spots and slits. One day Mountcastle walked in on this scene, and was horror struck at the spectacle. The method was certainly inconvenient since we had to stare at the ceiling for the entire experiment. Then I remembered having seen in Mountcastle's laboratory a Horsley-Clarke head holder that was not only no longer being used but also had the name of the Wilmer Institute engraved on it. It was no other than the instrument that Talbot had designed for visual work when he and Marshall mapped out visual areas I and II in the cat in 1941⁴. For years Vernon had used it in his somatosensory work, but he had recently obtained a fancier one. Torsten and I decided to reclaim the Wilmer instrument, not without some trepidation. To give ourselves confidence we both put on lab coats, for the first and last times in our lives, and looking very professional walked over to Physiology. Though Mountcastle was his usual friendly and generous self, I suspect he was loath to part with this treasure, but the inscription on the stainless steel was not to be denied and we walked off with it triumphantly. It is still in use (now at Harvard; we literally stole it from the Wilmer), and has probably the longest history of uninterrupted service of any Horsley-Clarke in the world.

A short while before this adventure we had gone to a lecture by Vernon (this was a few years after the discovery of cortical columns)⁵ in which he had amazed us by reporting on the results

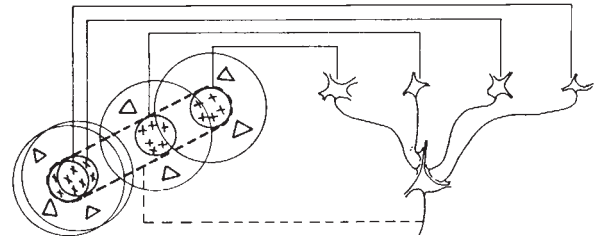

Fig. 4 Possible scheme for explaining the organization of simple receptive fields. A large number of lateral geniculate cells, of which four are illustrated on the right, have receptive fields with ON-centres arranged along a straight line on the retina. All of these project onto a single cortical cell, and the synapses are supposed to be excitatory. The receptive field of the cortical cell will then have an elongated ON-centre, indicated by the interrupted lines in the receptive-field diagram (left) (Fig. 19 in ref. 10).

of recording from some 900 somatosensory cortical cells, for those days an astronomic number. We knew we could never catch up, so we catapulted ourselves to respectability by calling our first cell No. 3000 and numbering subsequent ones from there. When Vernon visited our circus tent we were in the middle of a three-unit recording, cells number 3007, 3008 and 3009. We made sure that we mentioned their identification numbers. All three cells had the same receptive-field orientation, but neither Vernon nor we realized, then, what that implied.

Our first real discovery came about as a surprise. We had been doing experiments for about a month. We were still using the Talbot-Kuffler ophthalmoscope and were not getting very far; the cells simply would not respond to our spots and annuli. One day we made an especially stable recording. [We had adapted my technique for recording, which used long-term implantations and the Davies closed chamber⁶, to the short-term experiments, and no vibrations short of an earthquake were likely to dislodge things.] The cell in question lasted 9 hours, and by the end we had a very different feeling about what the cortex might be doing. For 3 or 4 hours we got

absolutely nowhere. Then gradually we began to elicit some vague and inconsistent responses by stimulating somewhere in the midperiphery of the retina. We were inserting the glass slide with its black spot into the slot of the ophthalmoscope when suddenly over the audiometer the cell went off like a machine gun. After some fussing and fiddling we found out what was happening. The response had nothing to do with the black dot. As the glass slide was inserted its edge was casting onto the retina a faint but sharp shadow, a straight dark line on a light background. That was what the cell wanted, and it wanted it, moreover, in just one narrow range of orientations.

This was unheard of. It is hard, now, to think back and realize just how free we were from any idea of what cortical cells might be doing in an animal's daily life. That the retinas mapped onto the visual cortex in a systematic way was, of course, well known, but it was far from clear what this apparently unimaginative remapping was good for. It seemed inconceivable that the information would enter the cortex and leave it unmodified, especially when Kuffler's work in the retina had made it so clear that interesting transformations took place there between input and output. One heard the word 'analysis' used to describe what the cortex might be doing, but what one was to understand by that vague term was never spelled out. In the somatosensory cortex, the only other cortical area being closely scrutinized, Mountcastle had found that the cells had properties not dramatically different from those of neurones at earlier stages.

Many of the ideas about cortical function then in circulation seem in retrospect almost outrageous. One has only to remember the talk of 'suppressor strips', reverberating circuits, or electrical field effects. This last notion was taken so seriously that no less a figure than our laureate-colleague Roger Sperry had had to put it to rest, in 1955, by dicing up the cortex with mica plates to insulate the subdivisions, and by skewering it with tantalum wire to short out the fields, neither of which procedures seriously impaired cortical function^{7,8}. Nevertheless, the idea of ephaptic interactions was slow to die out. There were even doubts as to the existence of topographic representation, which was viewed by some as a kind of artefact. One study, in which a spot of light projected anywhere in the retina evoked potentials all over the visual cortex, was interpreted as a refutation of topographic representation, but the result almost certainly came from working with a dark-adapted cat and a spot so bright that it scattered light all over the retina. It is surprising, in retrospect, that ideas of nonlocalization could survive in the face of the masterly mapping of visual fields onto the cortex in rabbit, cat and monkey done by Talbot and Marshall far back in 1941⁴.

It took us months to convince ourselves that we were not at the mercy of some optical artefact, such as anyone can produce by squinting their eyes and making vertical rays emanate from street lights. We did not want to make fools of ourselves quite

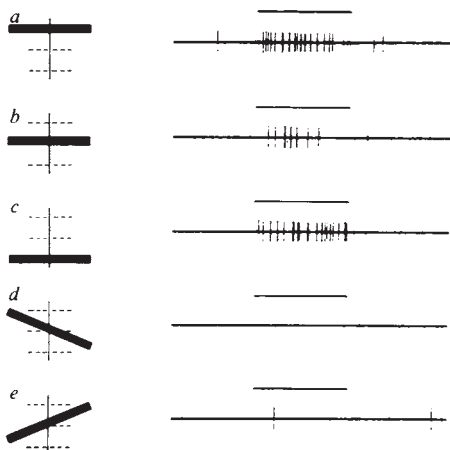

Fig. 5 a-c, Complex cell responding best to a black, horizontally oriented rectangle placed anywhere in the receptive field. d, e, Tilting the stimulus rendered it ineffective.

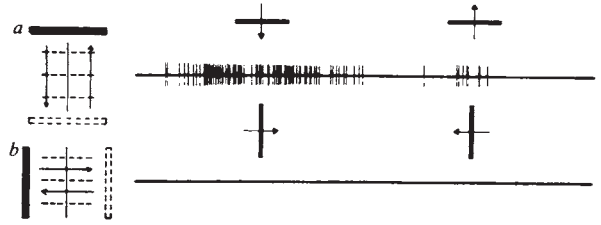

Fig. 6 Same cell as for Fig. 5, showing response to a moving horizontal bar. a, Downward movement was superior to upward; b, there was no response to a moving vertical bar (Figs 7 and 8 in ref. 10).

so early in our careers. But recording in sequence in the same penetration several cells, with several different optimal orientations would, I think, have convinced anyone. By January we were ready to take the cells we thought we could understand (we later called them 'simple cells') and write them up. Then, as always, what guided and sustained us was the attitude of Kuffler, who never lectured or preached but simply reacted with buoyant enthusiasm whenever he thought we had found something interesting, and acted vague and noncommittal when he found something dull.

Hierarchy of visual cells

During the years 1959-62, first at the Wilmer Institute and then at Harvard Medical School, we were mainly concerned with comparing responses of cells in the lateral geniculate body and primary visual cortex of the cat. In the lateral geniculate we quickly confirmed my Walter Reed finding that the receptive fields are like those of retinal ganglion cells in having an antagonistic concentric centre-surround organization. But now we could directly compare the responses of a geniculate cell with those of a fibre from an afferent retinal ganglion cell, and we found that in geniculate cells the power of the receptive-field surround to cancel the input from the centre was increased. This finding was subsequently confirmed and extended in a beautiful set of experiments by Cleland *et al.*⁹, and for many years it remained the only known function of the lateral geniculate body.

In the cat striate cortex it soon became evident that the cells were more complex than geniculate cells, and came in several degrees of complexity¹⁰. One set of cells could be described by techniques similar to those used in the retina by Kuffler; we called these 'simple'^{11,12}. Their receptive fields, like the fields of retinal ganglion cells and of lateral geniculate cells, were subdivided into antagonistic regions, illumination of any one of which tended to increase or decrease the rate of firing. But simple cells differed from retinal ganglion cells and lateral geniculate cells in the striking departure of their receptive fields from circular symmetry; instead of a single circular boundary between centre and surround, the antagonistic subdivisions were separated by parallel straight lines whose orientation (vertical, horizontal or oblique) soon emerged as a fundamental property (Fig. 2). The optimal stimulus—a slit, dark bar or edge—was easily predictable from the geometry of the receptive field, so that a stationary line stimulus worked optimally when its boundaries coincided with the boundaries of the subdivisions (Fig. 3), and displacing the line to a new position parallel to the old one generally resulted in a sharp decline in the response. Perhaps most remarkable was the precision of the spatial distribution of excitatory and inhibitory effects: not only did diffuse light produce no response (as though the excitatory and inhibitory effects were mutually cancelling with the precision of an acid-base titration), but any line oriented 90° to the optimal was also without effect, regardless of its position along the field, suggesting that the subpopulations of receptors so stimulated also had precisely mutually cancelling effects.

In the cat, simple cells are mostly found in layer 4, which is the site of termination of the bulk of the afferents from the lateral geniculate body. The exact connections that lead to orientation specificity are still unknown, but it is easy to think

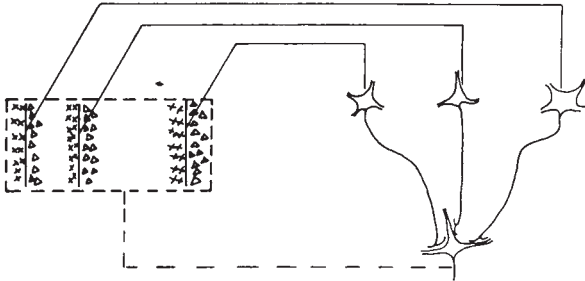

Fig. 7 Possible scheme for explaining the organization of complex receptive fields. A number of cells with simple fields, of which three are shown schematically, are imagined to project to a single cortical cell of higher order. Each projecting neurone has a receptive field arranged as shown to the left: an excitatory region to the left and an inhibitory region to the right of a vertical straight-line boundary. The boundaries of the fields are staggered within an area outlined by the interrupted lines. Any vertical-edged stimulus falling across this rectangle, regardless of its position, will excite some simple-field cells, leading to excitation of the higher-order cell (Fig. 20 in ref. 10).

of plausible circuits. For example, the behaviour of one of the commonest kinds of simple cells may be explained by supposing that the cell receives convergent excitatory input from a set of geniculate cells whose ON-centres are distributed in overlapping fashion over a straight line (Fig. 4). In the monkey, the cells of layer 4C (where most geniculate fibres terminate) all seem to be concentric centre-surround, and the simple layers immediately superficial to 4C. No one knows why this extra stage of centre-surround cells is intercalated in the monkey's visual pathway.

The next set of cells we called 'complex' because their properties cannot be derived in a single logical step from those of lateral geniculate cells (or, in the monkey, from the concentric cells of layer 4C). For the complex cell (compared with the simple cell), the position of an optimally oriented line need not be so carefully specified: the line works anywhere in the receptive field, evoking about the same response wherever it is placed (Fig. 5). This can most easily be explained by supposing that the complex cell receives inputs from many simple cells, all of whose receptive fields have the same orientation but differ slightly in position (Fig. 7). Sharpness of tuning for orientation varies from cell to cell, but the optimal orientation of a typical complex cell in layer 2 or 3 in the monkey can be easily determined to the nearest $5-10^\circ$, with no more stimulating equipment than a slide projector and a screen.

For a complex cell, a properly oriented line produces especially powerful responses when it is swept across the receptive field (Fig. 6). The discharge is generally well sustained as long as the line keeps moving, but falls off quickly if the stimulus is stationary. About half of the complex cells fire much better to one direction of movement than to the opposite direction, a quality called 'directional selectivity', which probably cannot be explained by any simple projection of simple cells onto complex cells, but seems to require inhibitory connections with time delays of the sort proposed for rabbit retinal ganglion cells by Barlow and Levick¹³.

Many cat or monkey cells, perhaps 10 to 20% in area 17, respond best to a line (a slit, an edge, or a dark bar) of limited length; when the line is prolonged in one direction or both, the response falls off. This is called 'end stopping'. In some cells the response to a very long line fails completely (Fig. 8)¹⁴. We originally called these cells 'hypercomplex' because we looked on them as next in an ordered hierarchical series, after the simple and the complex. We saw hypercomplex cells first in areas 18 and 19 of the cat, and only later in area 17. Dreher subsequently found cells, in all other ways resembling simple cells, that showed a similar fall-off in response as the length of the stimulus exceeded some optimum¹⁵. It seems awkward to call these cells hypercomplex: they are probably better termed

'simple end-stopped', in contrast to 'complex end-stopped'.

Complex cells come in a wide variety of subtypes. Typical cells of layers 2 and 3 have relatively small receptive fields and low spontaneous activity, and in the monkey may be not only highly orientation-selective but also fussy about wavelength, perhaps responding to red lines but not white. They may or may not be end-stopped. Cells in layers 5 and 6 have larger fields. Those in layer 5 have high spontaneous activity, and many respond just as well to a very short moving line as to a long one. Many cells in layer 6 respond best to very long lines¹⁶. These differences are doubtless related to the important fact, first shown with physiological techniques by Toyama *et al.*¹⁷ and confirmed and extended by anatomical techniques, that different layers project to different destinations—the upper layers mainly to other cortical regions; layer 5 to the superior colliculus, pons and pulvinar; and layer 6 back to the lateral geniculate body and to the claustrum.

In the past 10 or 15 years the subject of cortical receptive-field types has become rather a jungle, partly because the terms simple and complex are used differently by different people and partly because the categories themselves are not cleanly separated. Our original idea was to emphasize the tendency towards increased complexity as one moves centrally along the visual path and the possibility of accounting for a cell's behaviour in terms of its inputs. The circuit diagrams we proposed were just a few examples from a number of plausible possibilities. Even today the actual circuit by which orientation specificity is derived from centre-surround cells is unknown, and indeed the techniques necessary for solving this may still not be available. One can nevertheless say that cells of different complexities whose receptive fields are in the same part of the visual field and which have the same optimal orientation are likely to be interconnected, whereas cells with different optimal orientations are far less likely to be interconnected. In the monkey, a major difficulty with the hierarchical scheme outlined here is the relative scarcity of simple cells, compared with the huge numbers of cells with concentric fields in layer 4C or with the large number of complex cells above and below layer 4.

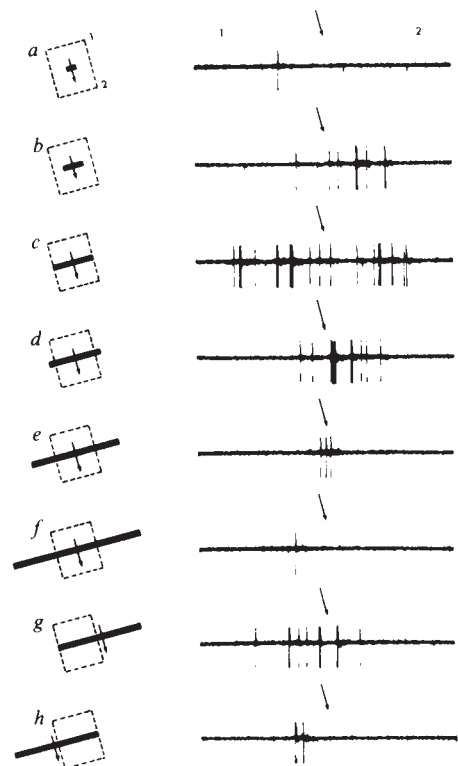

Fig. 8 Hypercomplex cell responding to a black bar oriented from 2:30 to 8:30, moving downward. The optimum response occurred when a stimulus swept over area outlined (c); stimulating more than this region (d-h), or less (a or b), resulted in a weaker response. Sweep duration, 2.5 s (Fig. 19 in ref. 14).

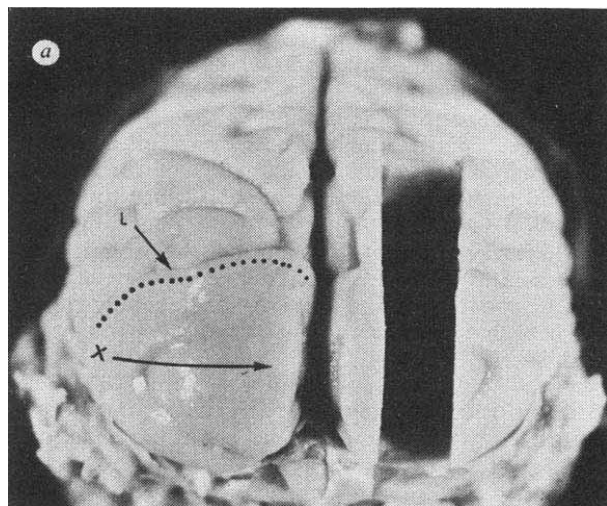

Fig. 9 *a*, Brain of a macaque, pertused with formalin, viewed from above and behind. The occipital lobe is demarcated in front by the lunate sulcus (L) and consists mainly of the striate cortex, area 17, which occupies most of the smooth surface, extending forward to the dotted line (the 17-18 border). If followed medially, area 17 curves around the medial surface of the brain and continues in a complex buried fold, a part of which lies underneath the convexity and parallel to it. X marks the projection of the fovea; movement in the direction of the arrow corresponds to movement along the horizon; movement along the dotted line, to movement down along the vertical midline of the visual field. The groove in the right hemisphere was made by removing a parasagittal block of tissue to produce the cross-section of *b* (Fig. 6a in ref. 29). *b*, Low power Nissl-stained section from a parasagittal block. It is what would be seen if one could stand in the groove of *a* and look to the left. A, outer convexity; B, the buried fold; arrows indicate the 17-18 borders, the upper right one of which is indicated by the dotted line in *a* (Fig. 6b in ref. 29). *c*, Cross-section through the monkey striate cortex stained with cresyl violet and showing conventional layering designations. W, white matter. Deeper layers (5 and 6) of the buried fold of the cortex are shown in the lower part of the figure (compare *b*) (Fig. 10 in ref. 29).



The fact that the simple cells have been found mainly in layer 4B also agrees badly with Jennifer Lund's finding that layer 4C β projects not to layer 4B but to layer 3. One has to consider the possibility that in the monkey the simple-cell step may be skipped, perhaps by summing the inputs from cells in layer 4 on dendrites of complex cells. In such a scheme each main dendritic branch of a complex cell would perform the function of a simple cell. All such speculation only emphasizes our ignorance of the exact way in which the properties of complex cells are built up.

Knowing how cortical cells respond to some visual stimuli and ignore others allows us to predict how a cell will react to any given visual scene. Most cortical cells respond poorly to diffuse light, so that when I gaze at a white object, say an egg, on a dark background I know that those cells in my area 17 whose receptive fields fall entirely within the boundaries of the object will be unaffected. Only the fields that are cut by the borders of the egg will be influenced, and then only if the local orientation of a border is about the same as the orientation of the receptive field. Slightly changing the position of the egg without changing its orientation will produce a dramatic change in the population of activated simple cells, but a much smaller change in the activated complex cells.

Orientation-specific simple or complex cells are specific for the direction of a short line segment. The cells are thus best not thought of as line detectors: they are no more line detectors than they are curve detectors. If our perception of a certain line or curve depends on simple or complex cells it presumably depends on a whole set of them, and how the information from such sets of cells is assembled at subsequent stages in the path to build up what we call percepts of lines or curves (if indeed anything like that happens at all) is still a complete mystery.

Architecture

By the early 1960s, our research had extended into four different but overlapping areas. Closest to conventional neurophysiology was the working out of response properties (receptive fields) of single cells. We became increasingly involved with architecture—the grouping of cells according to function into layers and columns, studied by electrode track reconstructions. This led in turn to experiments in which single-cell recording was combined with experimental anatomy. It began when one day James Sprague called to tell us that his chief histological technician, Jane Chen, was moving to Boston and needed a job: could we take her? Luckily we did (despite our not possessing anatomical union cards), and so acquired an expert in the Nauta method of making lesions in nervous tissue and selectively staining the degenerating axons. It seemed a terrible waste not to use this method and we soon got the idea of working out detailed pathways by making microelectrode lesions that were far smaller than conventional lesions and could be precisely placed by recording with the same electrodes. It became possible to make lesions in single layers of the lateral geniculate body, with results to be discussed shortly. Finally, another phase of our work involved studies of newborn animals' postnatal development and the effects of distorting normal sensory experience in young animals. This began in 1962 and grew steadily. Torsten Wiesel will discuss these experiments in the next issues of *Nature*.

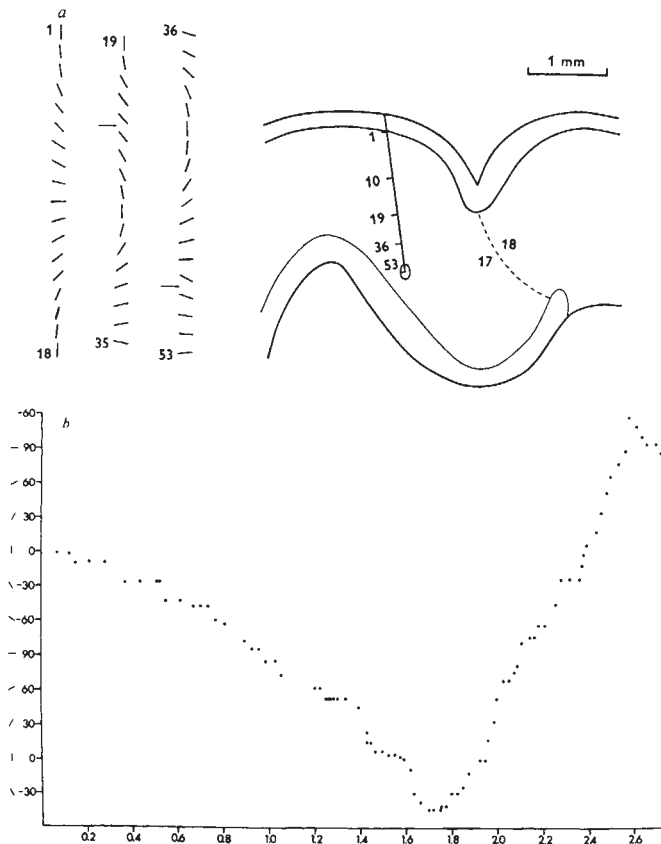

Fig. 10 *a*, Reconstruction of a penetration through the striate cortex about 1 mm from the 17–18 border, near the occipital pole of a spider monkey called George. To the left of the figure, the lines indicate receptive-field orientations of cells in the columns traversed; each line represents one or several units recorded against a rich unresolved background activity. Arrows indicate reversal of directions of shifts in orientation³². *b*, Graph of stimulus orientation in degrees versus distance along the electrode track in millimetres, in the experiment shown in *a*. Vertical is taken as 0°, clockwise is positive and anticlockwise negative.

Orientation columns

What our three simultaneously recorded cells, numbers 3009, 3010 and 3011, mapped out on the overhead sheet in September 1958 with their parallel orientation axes and separate but overlapping field positions, were telling us was that neighbouring cells have similar orientations but slightly different receptive-field positions. We of course knew about Mountcastle's somatosensory columns, and we began to suspect that cells might be grouped in the striate cortex according to orientation; but to prove it was not easy (Fig. 9).

Our first indication of the beauty of the arrangements of cell groupings came in 1961 in one of our first recordings from the striate cortex of monkey, a spider monkey named George. In one penetration, which went into the cortex at an angle of about 45° and was 2.5 mm long, we were struck right away by something we had only seen hints of before. As the electrode advanced, the orientations of successively recorded cells progressed in small steps of about 10° for every advance of 50 μ m. We began the penetration about 8:00 p.m.; 5 hours later we had recorded 53 successive orientations without a single large jump in orientation (Fig. 10). During the entire time, in which I wielded the slide projector and Torsten mapped the fields, neither of us moved from our seats. Fortunately, our fluid intake that day had been modest. Though I have shown this illustration many times, so far only Francis Crick has asked why there was no interruption in layer 4C, where according to dogma the cells are not orientation-specific. The answer is that I do not know.

In the cat we had had occasional suggestions of similar orderliness, and so we decided to address directly the problem of the shape and arrangement of the groupings¹⁸. By making

several closely spaced oblique parallel penetrations, we convinced ourselves that the groupings were really columns in that they extended from the surface to white matter and had walls that were perpendicular to the layers. We next made multiple close-spaced penetrations, advancing the electrode just far enough in each penetration to record one cell or a group of cells. To map a few square millimetres of cortex this way required 50 to 100 penetrations, each of which took 10 to 15 minutes. We decided it might be better to change careers, perhaps to chicken farming. But although the experiments were by our standards exhausting they did succeed in showing that orientation columns in the cat are not generally pillars but parallel slabs that intersect the surface as either straight parallel stripes or swirls.

Reversals in direction of orientation shift (Fig. 10*a*) are found in most penetrations. They occur irregularly, on the average about once every millimetre, and not at any particular orientation such as vertical or horizontal. We still do not know how to interpret them. Between reversals the plots of orientation against electrode position are remarkably linear¹⁹. Once, to exercise a new programmable calculator, I actually determined the coefficient of linear correlation of such a graph. It was 0.998, which I took to mean that the line must be very straight indeed.

For some years we had the impression that regular sequences like the one shown in Fig. 10 are rare—that most sequences are either more or less random or else the orientation hovers around one angle for some distance and then goes to a new angle and hovers there. Chaos and hovering do occur but they are exceptional, as are major jumps of 45° to 90°. It took us a long time to realize that regularity is the rule, not the exception, probably because we did not begin making very oblique or tangential penetrations until the mid-1970s. For these experiments to be successful requires electrodes coarse enough to record activity throughout a penetration, and not simply every 100 μ m or so. Such electrodes look less aesthetically pleasing, a fact that I think has happily tended to keep down the competition.

Our attempts to learn more about the geometry of orientation columns in the monkey by using the 2-deoxy-D-glucose technique²⁰ suggest that iso-orientation lines form a periodic pattern but are far from straight, being full of swirls and interruptions. Experiments done since then²¹ suggest that the deoxyglucose is probably also labelling the cytochrome blobs (see below). Similar work in the tree shrew by Humphrey *et al.*²² has shown

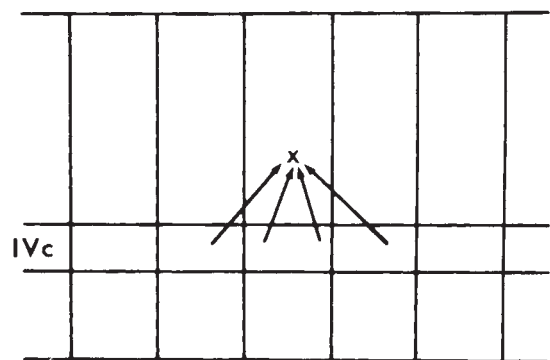

Fig. 11 Wiring of a binocular cell in a layer above (or below) layer 4C. In the macaque, the bulk of the afferents to the striate cortex from the lateral geniculate body, themselves monocular, are strictly segregated by eye affiliation in layer 4C, and thus the cells in this layer are strictly monocular. A cell outside layer 4C (X) receives its input connections, directly or indirectly by one or more synapses, from cells in layer 4C (to some extent also, perhaps, from layers 4A and 6). Cells in layer 4C will be more likely to feed into X the closer they are to it; consequently X is likely to be binocular, dominated by the eye corresponding to the nearest patch in 4C. The degree of dominance by that eye is greater, the closer X is to being centred in its ocular dominance column, and cells near a boundary may be roughly equally influenced by the two eyes (Fig. 12 in ref. 29).

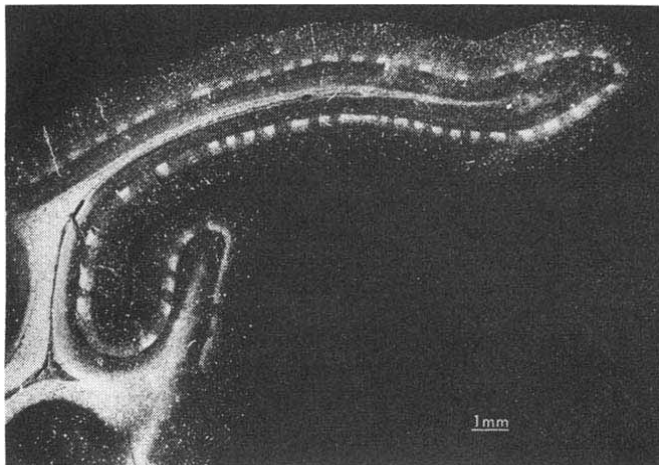

Fig. 12 Dark-field autoradiograph of the striate cortex in an adult macaque in which the ipsilateral eye had been injected with tritiated proline-fucose 2 weeks previously. Labelled areas show white. The section passes in a plane roughly perpendicular to the exposed surface of the occipital lobe and to the buried part immediately beneath (roughly, through the arrow of Fig. 9a). In all, about 56 labelled patches can be seen (Fig. 22 in ref. 29).

a much more regular pattern, and Stryker, Wiesel and I have seen more regularity in the cat (unpublished data). Both tree shrew and cat lack the cytochrome blobs.

Ocular dominance columns

A major finding in our 1959 and 1962 papers^{10,12}, besides the orientation selectivity, was the presence in the striate cortex of a high proportion of binocular cells. Since recordings from the lateral geniculate body had made it clear that cells at that stage are for all practical purposes monocular, this answered the question of where, in the retinogeniculocortical pathway, cells first received convergent input from the two eyes. More interesting to us than the mere binocularity was the similarity of a given cell's receptive fields in the two eyes in size, complexity, orientation and position. Presumably this forms the basis of the fusion of the images in the two eyes. It still seems remarkable that a cell should not only be wired with the precision necessary to produce complex or hypercomplex properties, but should have a duplicate set of such connections, one from each eye.

Although the optimum stimulus is the same for the two eyes, the responses evoked are not necessarily equal; for a given cell one eye is often consistently better than the other. It is as if the two sets of connections were qualitatively similar, but, for many cells, different in density. We termed this relative effectiveness of the two eyes 'eye preference' or 'relative ocular dominance'.

In the macaque it was evident from the earliest experiments that neighbouring cells have similar eye preferences. In vertical penetrations the preference remains the same all the way through the cortex. In layer 4C the cells are monocular, and here any cell is monopolized by the eye that merely dominates the cells in the layers above and below. In penetrations that run parallel to the layers eye preference alternates, with shifts roughly every 0.5 mm. The conclusion is that the terminals from cells of the lateral geniculate distribute themselves in layer 4C according to eye of origin, in alternating patches about 0.5 mm wide. In the layers above and below layer 4, horizontal and diagonal connections lead to a mixing that is incomplete, so that a cell above a given patch is dominated by the eye supplying that patch but receives subsidiary input from neighbouring patches (Fig. 11).

The geometry of these layer-4 patches was finally determined by several independent anatomical methods, the first of which²³ was the Nauta method and its modifications for staining terminals worked out first by Fink and Heimer and then by a most able and energetic research assistant, Janet Wiitanen. By making small lesions in single geniculate layers, we were able to

see the patchy distribution of degenerating terminals in layer 4, which, in a face-on view, takes the form not of circumscribed patches but of parallel stripes. We also showed that the ventral (magno-cellular) pair of layers projects to the upper half of layer 4C (subsequently called 4C α by Jennifer Lund), whereas the dorsal four layers project to the lower half (4C β), and that the line of Gennari (4B), once thought to receive the strongest projection, is actually almost bereft of geniculate terminals.

While the Nauta studies were still in progress, we read Bernice Grafstein's report that radioactive label injected into

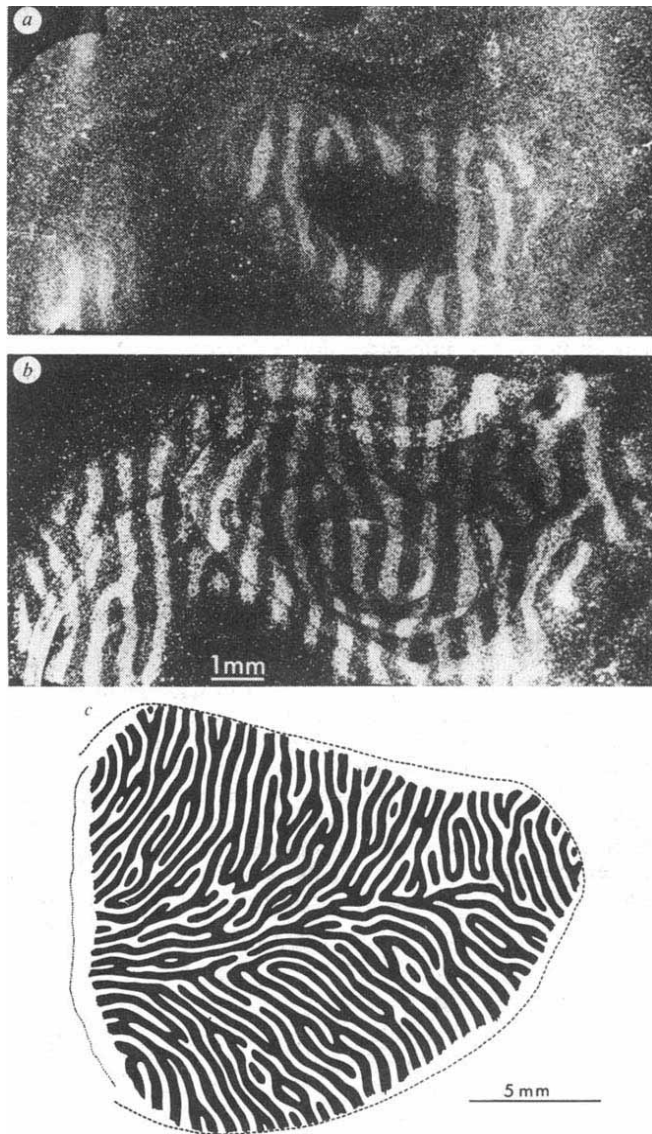

Fig. 13 Autoradiographs from the same (normal) animal as in Fig. 12, but from the hemisphere contralateral to the injected eye (dark field). *a*, A section tangential to the exposed dome-like surface of the occipital lobe, just grazing layer 5, which appears as an oval, surrounded by layer 4C which appears as a ring containing the labelled parallel bands, which appear light against the dark background. *b*, A composite made by cutting up layer 4C from a number of parallel sections such as the one shown in *a* and pasting them together to show the bands over an area some millimetres in extent. *c*, Reconstruction of layer 4C ocular dominance columns over the entire exposed part of area 17 in the right occipital lobe shown in Fig. 9a. The line on the left represents the midsagittal plane, where the cortex bends around. The dashed reversed c-shaped curve is the 17-18 border, whose apex, to the extreme right, represents the fovea. Every other column has been blacked in to exhibit the twofold nature of the set of subdivisions. Note the relative constancy of column widths.

the eye of a rat could be detected in the contralateral visual cortex, as though transneuronal transport had taken place in the geniculate²⁴. (The rat retinogeniculocortical pathway is mainly crossed.) It occurred to us that if we injected the eye of a monkey we might be able to see autoradiographic label in area 17. We tried it, but could see nothing. Soon after, while visiting Ray Guillery in Wisconsin, I saw some amino acid transport autoradiographs which showed nothing in light field but in which label was obvious in dark field. I rushed back, we got out our slides, borrowed a dark-field condenser and found beautiful alternating patches throughout all the binocular part of area 17²⁵ (Fig. 12). This method allowed us to reconstruct ocular dominance columns over much wider expanses than could be mapped with the Nauta method (Fig. 13). It led to a study of the pre- and postnatal visual development of ocular dominance columns and the effects of visual deprivation on the columns, which Torsten Wiesel will describe.

Relationship between columns, magnification and field size

To me the main pleasures of doing science are in getting ideas for experiments, doing surgery, designing and making equipment, and above all the rare moments in which some apparently isolated facts click into place like a Chinese puzzle. When a collaboration works, as ours has, the ideas and the clicking into place often occur simultaneously or collaboratively; usually neither of us has known (or cared about) which of us originally produced an idea, and sometimes one idea has occurred to one of us, only to be forgotten and later resurrected by the other. One of the most exciting moments was the realization that our orientation columns, extending through the full thickness of the cat cortex, contain just those simple and complex cells (later we could add the hypercomplex) that our hierarchical schemes had proposed were interconnected¹⁰. This gave the column a meaning: a little machine that takes care of contours in a certain orientation in a certain part of the visual field. If the cells of one set are to be interconnected, and to some extent isolated from neighbouring sets, it makes obvious sense to gather them together. As Lorente de Nó showed²⁶, most of the connections in the cortex run up and down; lateral or oblique connections tend to be short (mostly limited to 1–2 mm) and less rich. These ideas were not entirely new since Mountcastle had clearly enunciated the principle of the column as an independent unit of function. What was new in the visual cortex was a clear function for the columns, the transformation of information

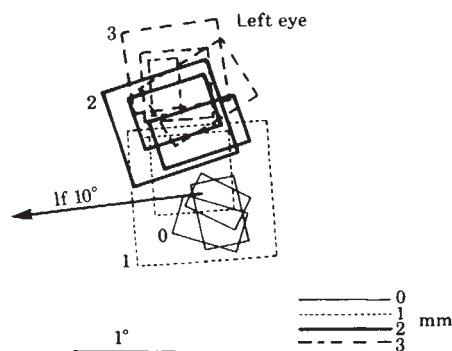

Fig. 14 Receptive-field drift. Receptive fields mapped during on oblique, almost tangential, penetration through the striate cortex. A few fields were mapped along each of four 100- μ m segments, spaced at 1-mm intervals. These four groups of fields are labelled 0, 1, 2, and 3. Along any one of these 100- μ m segments no systematic progression of receptive fields could be seen; any such movement was obscured by the random scatter. But from one segment to the next there was a clear movement: each new set of fields was slightly above the other in the visual field, as predicted from the direction of movement of the electrode and from the topographic map of visual fields onto the cortex. Roughly a 2-mm movement through cortex was required to displace the fields from one region to an entirely new region (Fig. 2 in ref. 28).

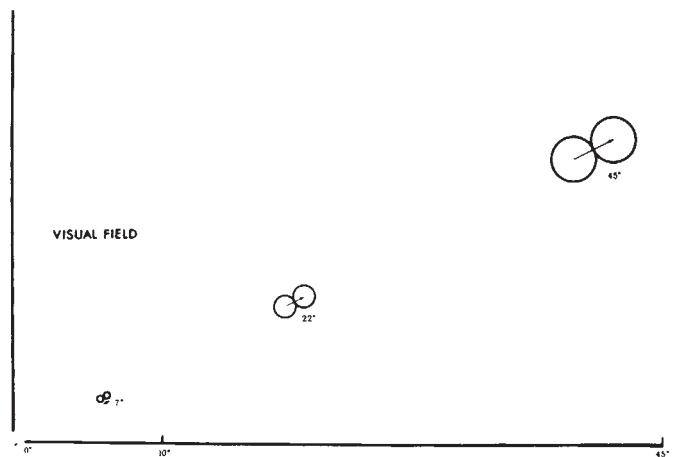

Fig. 15 Variation of receptive-field drift with eccentricity. The diagram represents one quadrant of the field of vision, and the circles represent aggregate receptive fields—the territory collectively occupied by receptive fields of cells encountered in a micro-electrode penetration perpendicular to the cortical surface. Each pair of circles illustrates the movement in aggregate receptive fields accompanying a tangential movement along the cortex of 1–2 mm. Both the displacement and the aggregate field size vary with distance from the fovea (eccentricity), but they do so in parallel fashion. Close to the fovea the fields are tiny, but so is the displacement accompanying a 1–2-mm movement along the cortex. (At 0° eccentricity, displacement and aggregate field size are both too small to be reproduced in this figure.) The greater the distance from the fovea, the greater the two become, but they continue to remain roughly equal²⁸.

from circularly symmetric form to orientation-specific form, and the stepwise increase in complexity.

A similar argument applies to the ocular dominance columns, a pair of which constitutes a machine for combining inputs from the two eyes—combining, but not completely combining, in a peculiar grudging way for reasons still not at all clear, but probably related in some way to stereopsis. (Whatever the explanation of the systematically incomplete blending, it will have to take into account the virtual but not complete absence of dominance columns in squirrel monkeys.) If the eyes are to be kept to some extent functionally separate, it is economical of connections to pack together cells of a given eye preference.

To my mind our most aesthetically attractive and exciting formulation has been the hypercolumn and its relation to magnification. The idea grew up gradually, but took an initial spurt as a result of a question asked by Werner Reichardt during a seminar that I gave in Tübingen. I had been describing the ordered orientation sequences found in monkeys like George, when Werner asked how one avoided the difficulty arising from the fact that as you move across the cortex, visual field position is changing in addition to orientation. Could this mean that if you looked closely you would find, in one small part of the visual field, only a small select group of orientations represented? The question seemed silly (at first), and I explained that in any one part of the visual field all orientations are represented, in fact probably several times over. Afterwards the question nagged me. There must be more to it than that. We began to put some seemingly isolated facts together. The visual fields map systematically onto the cortex but the map is distorted: the fovea is disproportionately represented, with 1 mm about equivalent to 1/6° of visual field. As one goes out in the visual field the representation falls off logarithmically, as Daniel and Whitteridge had shown²⁷, so that in the far periphery the relationship is more like 1 mm = 6°. Meanwhile the average size of receptive fields grows from centre of gaze to periphery. This is not unexpected when one considers that in the fovea our acuity is much higher than in the periphery. To do the job in more detail takes more cells, each looking after a smaller region; to accommodate the cells takes more cortical surface area. I had always been surprised that the part of the cortex

representing the fovea is not obviously thicker than that representing the periphery: surprised, I suppose, because in the retina near the fovea, the ganglion is, in fact, many times thicker than in the periphery. The cortex must be going out of its way to keep its uniformity by devoting to the detailed tasks more area rather than more thickness.

We decided to look more carefully at the relationship between receptive field size and area of cortex per unit area of visual field²⁸. When an electrode pushed vertically through the cortex encounters a hundred or so cells in traversing the full thickness, the receptive fields vary to some extent in size, and in a rather random way in position, so that the hundred maps when superimposed cover an area several times that of an average receptive field. We call this the 'aggregate receptive field' for a particular point on the cortex. On making a penetration parallel to the surface, a gradual drift in field positions is superimposed on the random staggering, in a direction dictated by the topographic map (Fig. 14). We began to wonder whether any law connected the rate of this drift in aggregate position and the size of the fields. It turned out that for layers 2 and 3 a movement of about 2 mm across the cortex is just sufficient to produce a displacement, in the visual field, out of the region where one started and into an entirely new region. This held across the entire striate cortex (and consequently over the whole visual field). In the fovea the displacement was tiny and so were the fields. As one went out, both increased in size, in parallel fashion (Fig. 15). Now things seemed to mesh. George and other monkeys had taught us that a 1–2-mm movement across the cortex is accompanied by an angular shift in receptive field orientation of 180° to 360°, more than one full complement of orientations. We have termed such a set of orientation columns (180°) a hypercolumn. Meanwhile, the ocular dominance shifts back and forth to take care of both eyes every millimetre—a hypercolumn for ocular dominance. Thus in 1 or 2 mm² there seems to exist all the machinery necessary to look after everything the visual cortex is responsible for, in a certain small part of the visual world. The machines are the same everywhere; in

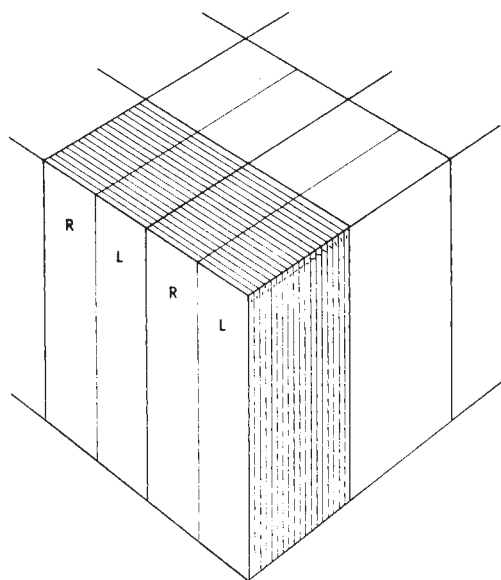

Fig. 16 Model of the striate cortex, to show roughly the dimensions of the ocular dominance slabs (L and R) in relation to the orientation slabs and the cortical thickness. Thinner lines separate individual columns: thicker lines demarcate the two pairs of ocular dominance columns and two sets of orientation columns. The placing of these hypercolumn boundaries is arbitrary: one could as well begin the orientation hypercolumn at horizontal or at any of the obliques. The decision to show the two sets of columns as intersecting at right angles is also arbitrary, since there is at present no evidence of the relationship between the two sets. For convenience, the slabs are shown as plane surfaces, but whereas the dominance columns are indeed more or less flat, the orientation columns are not known to be so, and when viewed from above, they may have the form of swirls (Fig. 27 in ref. 29).

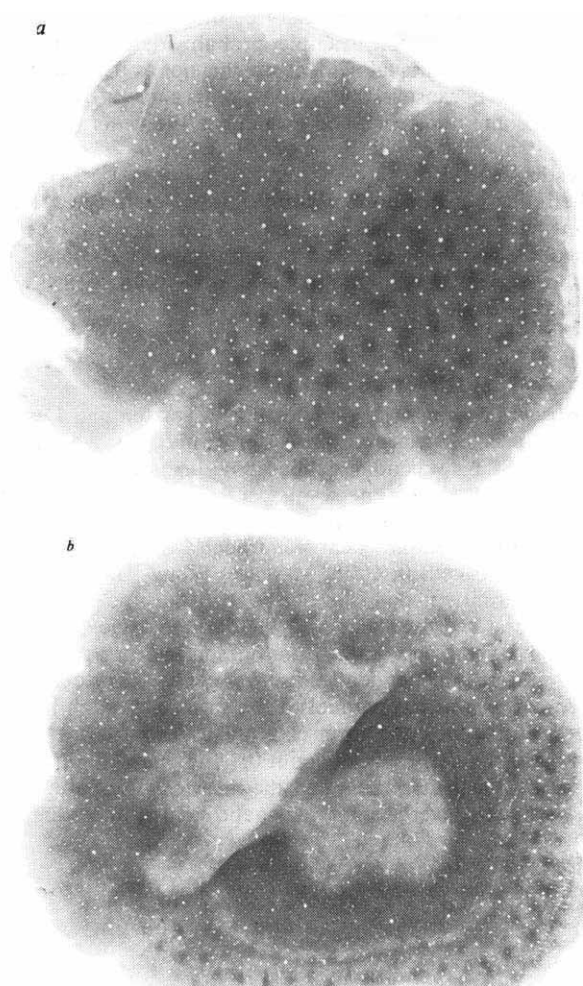

Fig. 17 Tangential sections (cytochrome oxidase stain) through the visual cortex of the squirrel monkey. The sections pass through the 17–18 border, which runs obliquely in the figure, with area 17 below and to the right and 18 above and to the left. (D.H.H. and M.S.L., unpublished data). *a*, The section passes through layer 3, and the blobs can be seen easily in area 17. *b*, The section is tangential to layer 5, where the blobs can again be seen, though faintly; these lie in register with the upper-layer blobs.

some parts the information on which they do their job is less detailed, but covers more visual field (Fig. 16).

Uniformity is surely a huge advantage in development, for genetic specifications need only be laid down for a 1–2-mm block of neural tissue, together with the instruction to make a thousand or so.

We could have called the entire machine a hypercolumn, but we did not. The term as we define it refers to a complete set of a given column. I mention this because in terminology, too, uniformity has some obvious advantages. Perhaps one could use 'module' to refer to the complete machine.

There are three qualifications to all of this. (1) I do not mean to imply that there need really be 2,000 separate definable entities. It need not matter whether one begins a set of orientation columns at vertical, horizontal or any one of the obliques; the decision is arbitrary. One requires two dominance columns, a left and a right, and it makes no difference which one begins with. (In fact, as will become apparent when I discuss cytochrome blobs, it now looks as though the blocks of tissue may really be discrete, to a degree that we could not have imagined 2 years ago.) (2) Because receptive fields are larger and connections longer in layers 5 and 6, compared with those of layers 2 and 3, a module defined for the deeper layers would be somewhat larger than 2×2 mm. In this sense, to think of modules as small chunks of cortex was an oversimplification. (3) There may well be some differences in cortical machinery

between the centre and periphery of the visual field. Colour vision and stereopsis, for example, probably decline in importance far out in the visual fields. I say this not to be obsessively complete but because in the next few years someone will probably find some difference and pronounce the general concept wrong. It may of course be wrong, but I hope it will be for interesting reasons.

The retina must be nonuniform if it is to do a more detailed job in the centre. To have more area devoted to the centre than to the periphery is not an option open to it, because it is a globe. Were it anything else the optics would be awkward and the eye could not rotate in its socket.

New developments

A few years ago, in a Ferrier Lecture²⁹, Torsten and I ended by saying that the striate cortex was probably, in broad outline, understood. This was done deliberately: one did not want the well to dry up. When one wants rain the best strategy is to leave raincoat and umbrella at home. So the best way to guarantee future employment was to declare the job finished. It certainly worked. In 1978, Margaret Wong-Riley observed regular intermittent puff-like densities in the upper layers of monkey striate cortex stained for the enzyme cytochrome oxidase, and 2 years ago Anita Hendrickson and her group and our laboratory independently discovered that if cytochrome-stained cortex was cut parallel to the surface through layer 3 these densities took the form of a polka-dot pattern of dark blobs quasi-regularly spaced about 0.5 mm apart (Fig. 17)^{21,30}. It is as if the animal's brain had the measles. The pattern has been seen with several other enzymatic stains, suggesting that

either the activity or the machinery is different in the blob regions. The pattern has been found in all primates examined, including humans, but not, so far as I know, in any non-primates. In the macaque the blobs are clearly lined up along ocular dominance columns²¹. Over the past year Margaret Livingstone and I have shown that the cells in the blobs lack orientation selectivity, resembling, at least superficially, cells of layer 4C³¹. They are selectively labelled after large injections of radioactive proline into the lateral geniculate body, so it is clear that their inputs are not identical to the inputs to the rest of layers 2 and 3. Thus an entire system has opened up, whose existence we were previously unaware of and whose anatomy and functions we do not yet understand. We are especially anxious to learn what, if any, relationship exists between the cytochrome blobs and the orientation columns.

Things are at an exciting stage. There is no point leaving the umbrella home; it is raining, and raining hard.

I thank the Eye Institute of the National Institutes of Health, the US Air Force, the Klingenstein Fund, and the Rowland Foundation for their generous support of our research; also, the Faculty of Harvard University for tolerating such a truculent colleague. I thank many research assistants who have helped Torsten Wiesel and me over the past 22 years, especially Jane Chen, Janet Wiitanen, Bea Storai, Jaye Robinson, Martha Egan, Joan Weisenbeck, Karen Larson, Sharon Mates, Debra Hamburger, Yu-Wen Wu, Sue Fenstermaker, Stella Chow, Sarah Kennedy, Maureen Packard and Mary Nastuk. For photographic assistance I thank Sandra Spinks, Carolyn Yoshikami and Marc Peloquin, in electronics and computers David Freeman, and Sheila Barton, Pat Schubert and Olivia Brum for secretarial help.

- Hubel, D. H. *Am. J. Ophthalmol.* **46**, 110 (1958).
- Barlow, H. B., FitzHugh, R. & Kuffler, S. W. *J. Physiol., Lond.* **137**, 327 (1957).
- Talbot, S. A. & Kuffler, S. W. *J. Opt. Soc. Am.* **42**, 931 (1952).
- Talbot, S. A. & Marshall, W. H. *Am. J. Ophthalmol.* **44**, 1255 (1941).
- Mountcastle, V. B. *J. Neurophysiol.* **20**, 408 (1957).
- Davies, P. W. *Science* **124**, 179 (1956).
- Sperry, R. W., Miner, N. & Myers, R. E. *J. comp. Physiol. Psychol.* **48**, 50 (1955).
- Sperry, R. W. & Miner, N. *J. comp. Physiol. Psychol.* **48**, 463 (1955).
- Cleland, B. G., Dubin, M. W. & Levick, W. R. *Nature new Biol.* **231**, 191 (1971).
- Hubel, D. H. & Wiesel, T. N. *J. Physiol., Lond.* **160**, 106 (1962).
- Hubel, D. H. & Wiesel, T. N. *21st Int. Congr. Physiol.*, Buenos Aires (1959).
- Hubel, D. H. & Wiesel, T. N. *J. Physiol. Lond.* **148**, 574 (1959).
- Barlow, H. B. & Levick, W. R. *J. Physiol., Lond.* **178**, 477 (1965).
- Hubel, D. H. & Wiesel, T. N. *J. Neurophysiol.* **28**, 229 (1965).
- Dreher, B. *Invest. Ophthalmol.* **11**, 355 (1972).
- Gilbert, C. D. *J. Physiol., Lond.* **268**, 391 (1977).
- Toyama, T., Matsunami, K. & Ohno, T. *Brain Res.* **14**, 513 (1969).
- Hubel, D. H. & Wiesel, T. N. *J. Physiol., Lond.* **165**, 559 (1963).
- Hubel, D. H. & Wiesel, T. N. *J. comp. Neurol.* **158**, 267 (1974).
- Sokoloff, L. *et al. J. Neurochem.* **28**, 897 (1977).
- Horton, J. C. & Hubel, D. H. *Nature* **292**, 762 (1981).
- Humphrey, A. L., Skeen, L. C. & Norton, T. T. *J. comp. Neurol.* **192**, 549 (1980).
- Hubel, D. H. & Wiesel, T. N. *J. comp. Neurol.* **146**, 421 (1972).
- Grafstein, B. *Science* **172**, 177 (1971).
- Wiesel, T. N., Hubel, D. H. & Lam, D. M.-K. *Brain Res.* **79**, 273 (1974).
- Lorente de N6, R. in *Physiology of the Nervous System*, 3rd edn (ed. Fulton, J. F.) (Oxford University Press, 1949).
- Daniel, P. M. & Whitteridge, D. *J. Physiol., Lond.* **159**, 203 (1961).
- Hubel, D. H. & Wiesel, T. N. *J. comp. Neurol.* **158**, 295 (1974).
- Hubel, D. H. & Wiesel, T. N. *Proc. R. Soc. B198* (1977).
- Hendrickson, A. E., Hunt, S. P. & Wu, J.-Y. *Nature* **292**, 605 (1981).
- Hubel, D. H. & Livingstone, M. S. *Soc. Neurosci. Abstr.* **7**, 357 (1981).
- Hubel, D. H. & Wiesel, T. N. *J. Physiol., Lond.* **195**, 215 (1968).
- LeVay, S., Hubel, D. H. & Wiesel, T. N. *J. comp. Neurol.* **159**, 559 (1975).

ARTICLES

Mafic segregations in ophiolite mantle sequences

J. G. Spray

Department of Earth Sciences, University of Cambridge, Cambridge CB2 3EQ, UK

Mafic segregations of picritic composition and high-temperature-high-pressure mineralogy are described from the mantle sequences of ophiolites and show similarities with parental magma to oceanic tholeiite and have escaped significant fractionation and re-equilibration due to ascent through an unperturbed geothermal gradient. Such conditions are uncharacteristic of mature spreading centres and indicate that the host ophiolites were generated during incipient rifting.

A HITHERTO little documented component of ophiolite complexes are mafic segregations found in association with ultramafic tectonites (Fig. 1). The host ultramafics are commonly plagioclase- or spinel-bearing lherzolites which occur as pods (km-size) surrounded by harzburgite; as intercalations (usually <1 km thick) parallel-banded with harzburgite tectonite fabrics, or as a basal zone to the ophiolite mantle sequence (usually <<1 km thick). Within the lherzolites, the

mafic segregations form thin discontinuous layers, pods or lenses (usually <10 cm thick) in parallel orientation with lherzolite tectonite fabrics or alternatively, discordant veins and dykelets. At higher levels in the mantle sequence the mafic segregations are similarly disposed but are often hosted by harzburgites. The segregations may exhibit granoblastic, mylonitic, schistose or gneissose textures indicative of sub-solidus deformation, or alternatively interlocking mineral